

Stärke
bis 14 mm
A/A Qualität

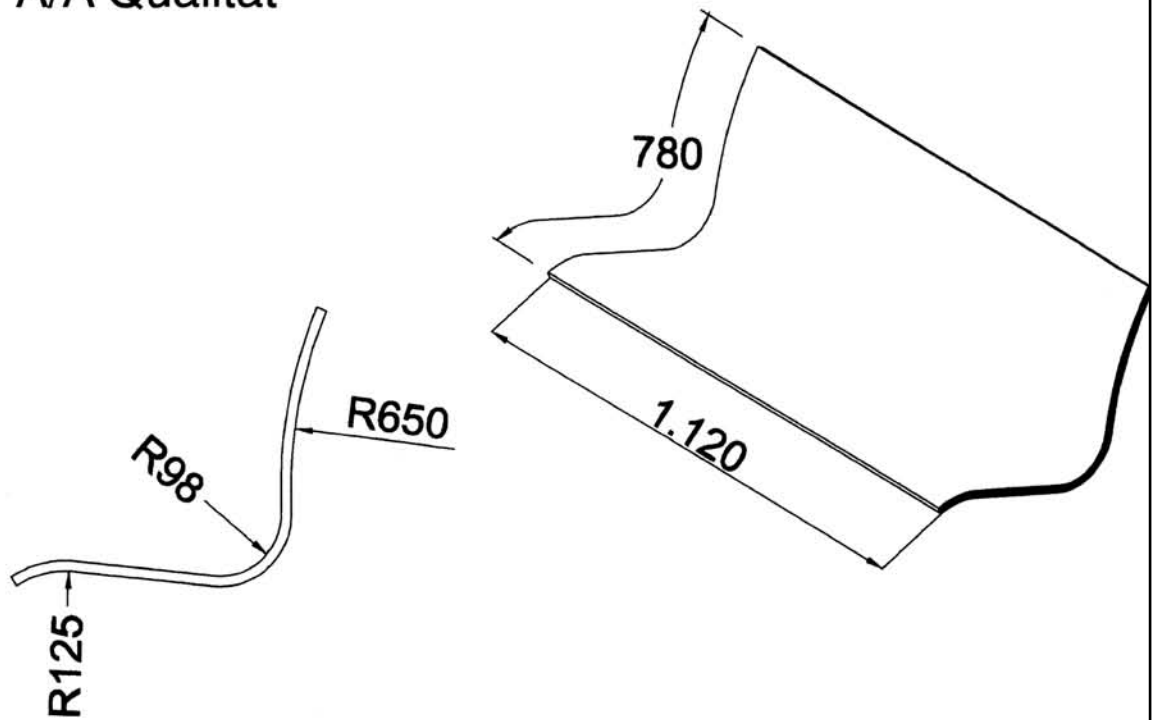

Form Nr. 405

Stärke
bis 10 mm

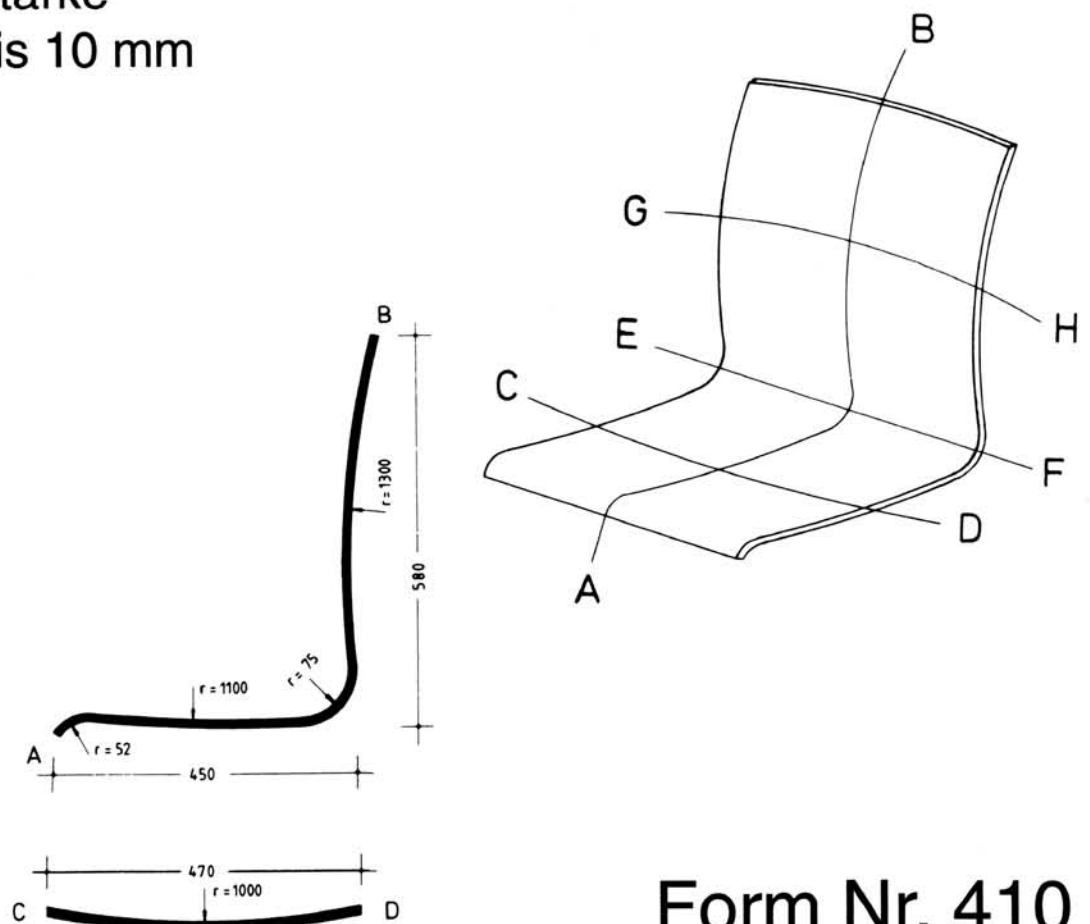

Form Nr. 410

Stärke
bis 14 mm

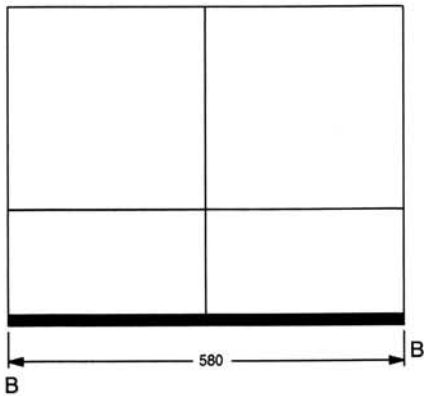
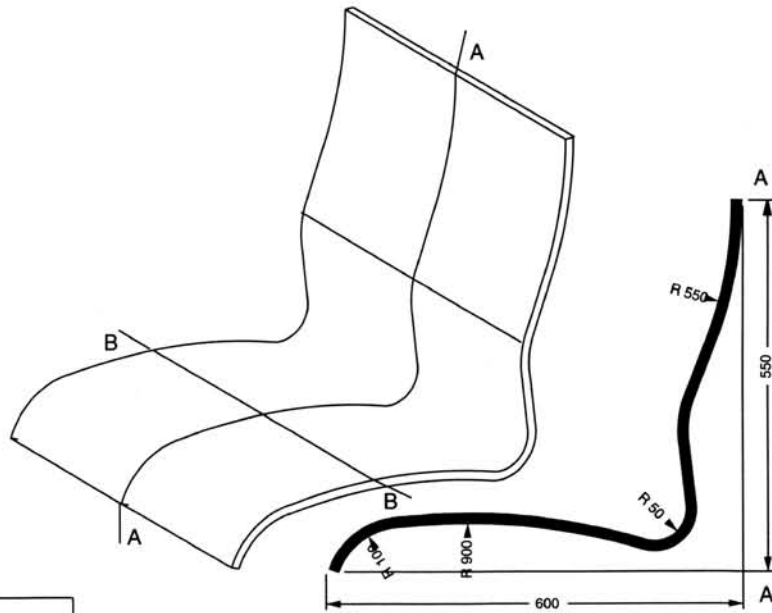

Form Nr. 416

Stärke
bis 10 mm

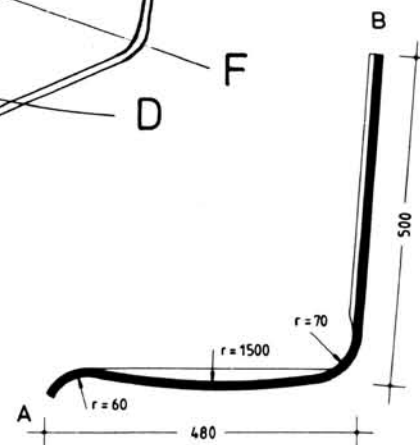
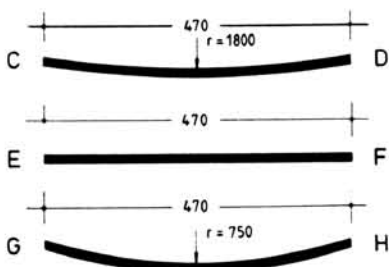
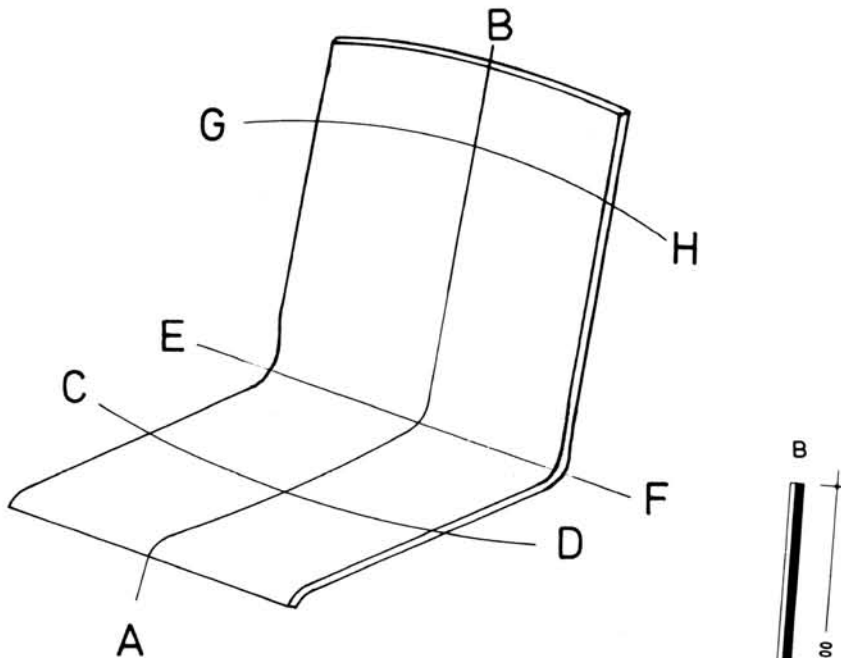

Form Nr. 420

Stärke
bis 10 mm

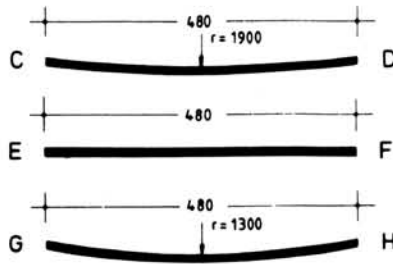
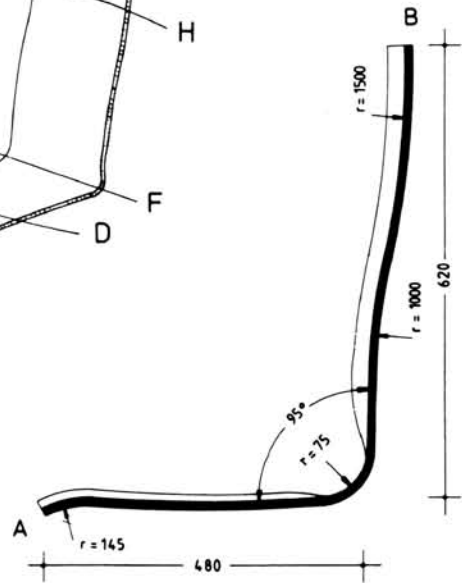
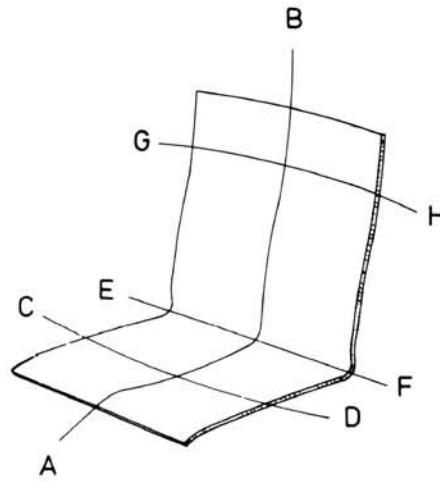

Form Nr. 421

Stärke
bis 10 mm

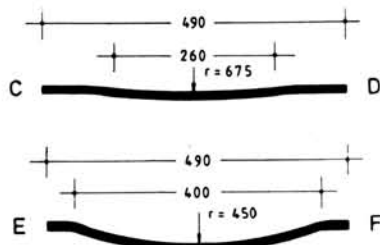
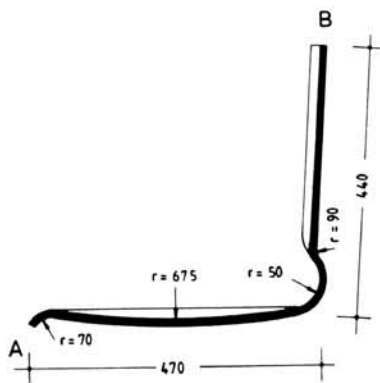
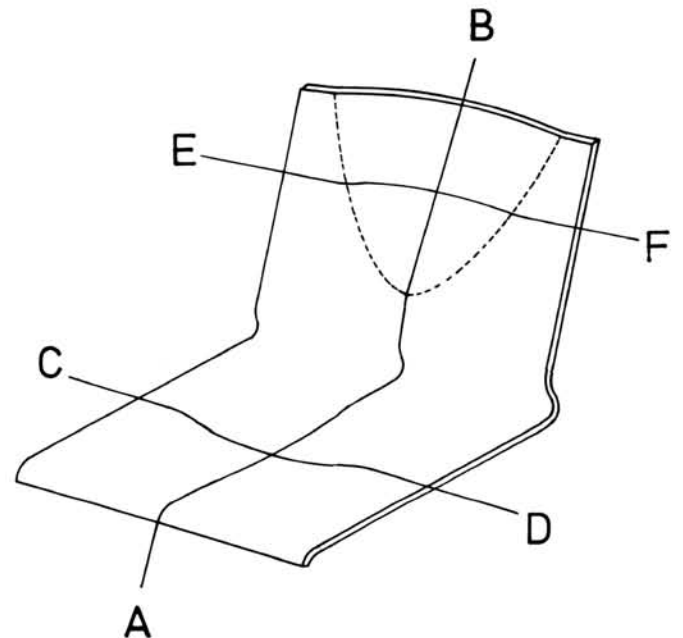

Form Nr. 430

Stärke
bis 10 mm

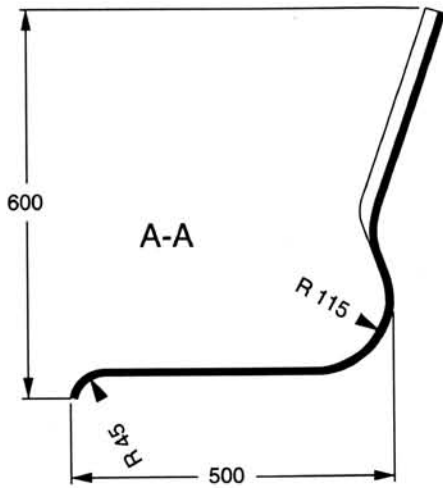
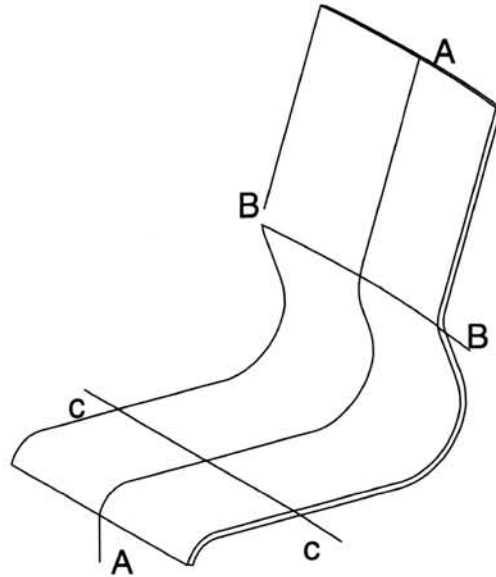
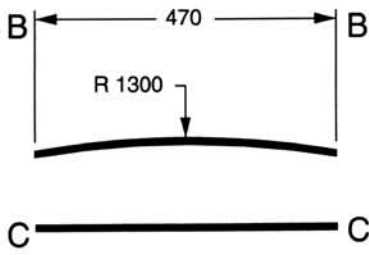

Form Nr. 436

Stärke
bis 10 mm

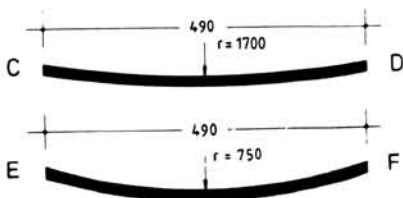
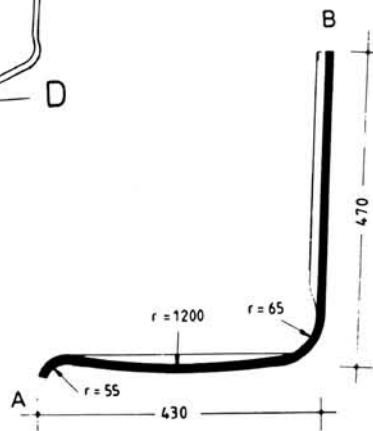
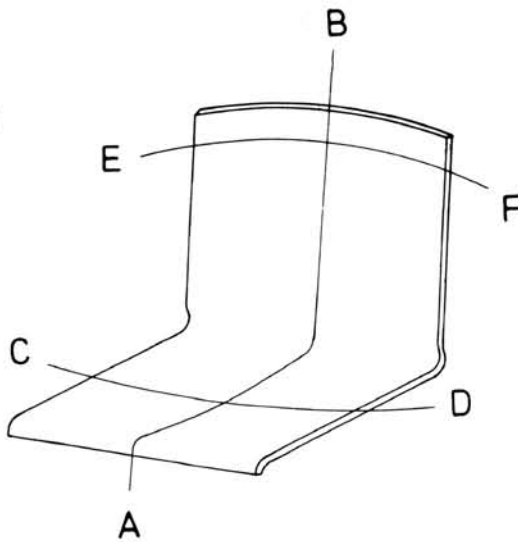

Form Nr. 440

Stärke
bis 9 mm

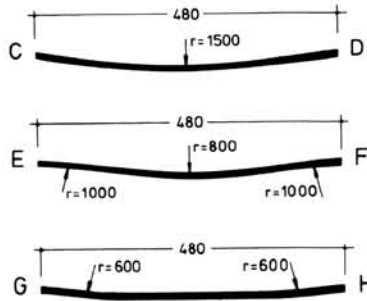
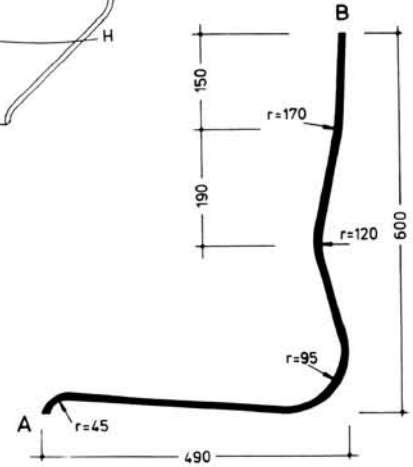
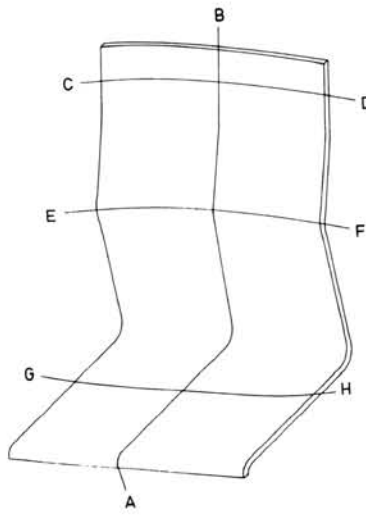

Form Nr. 451

Stärke
bis 15 mm

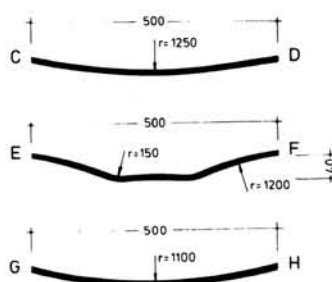
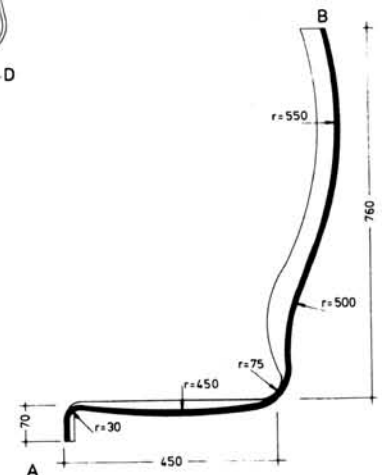
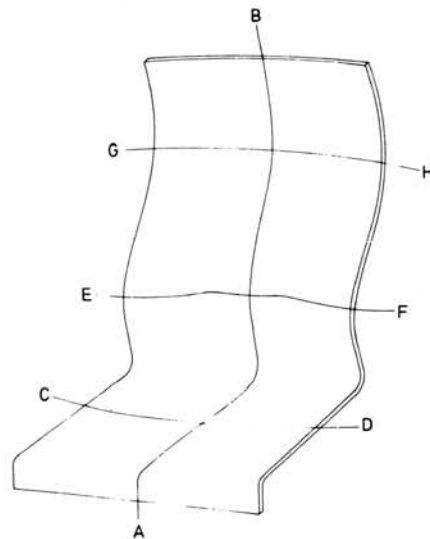

Form Nr. 465

**Stärke
bis 10 mm**

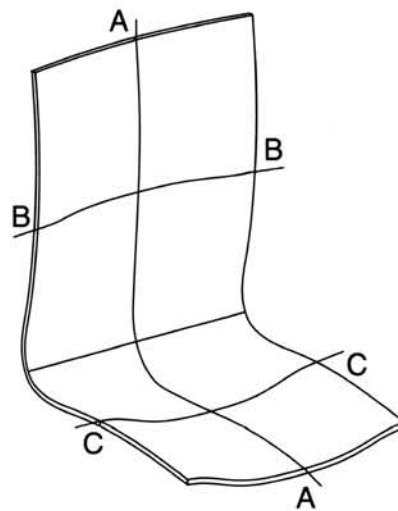
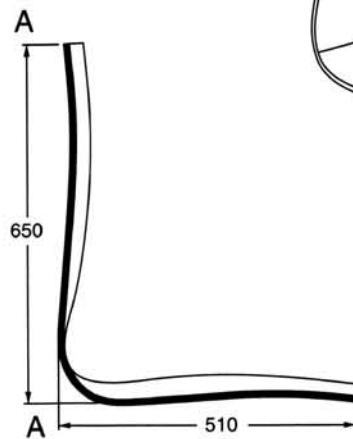
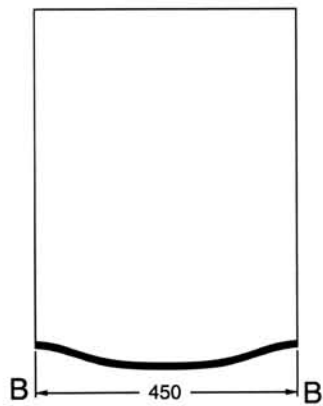
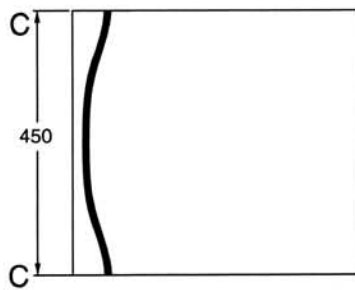

Form Nr. 480